

*Installation, operation
maintenance instructions
& spare parts list for
Molnar Air Jacking Beam*

JB11 / JB11A

AIR JACKING BEAM INSTRUCTIONS

**M
O
L
N
A
R**



HOISTS

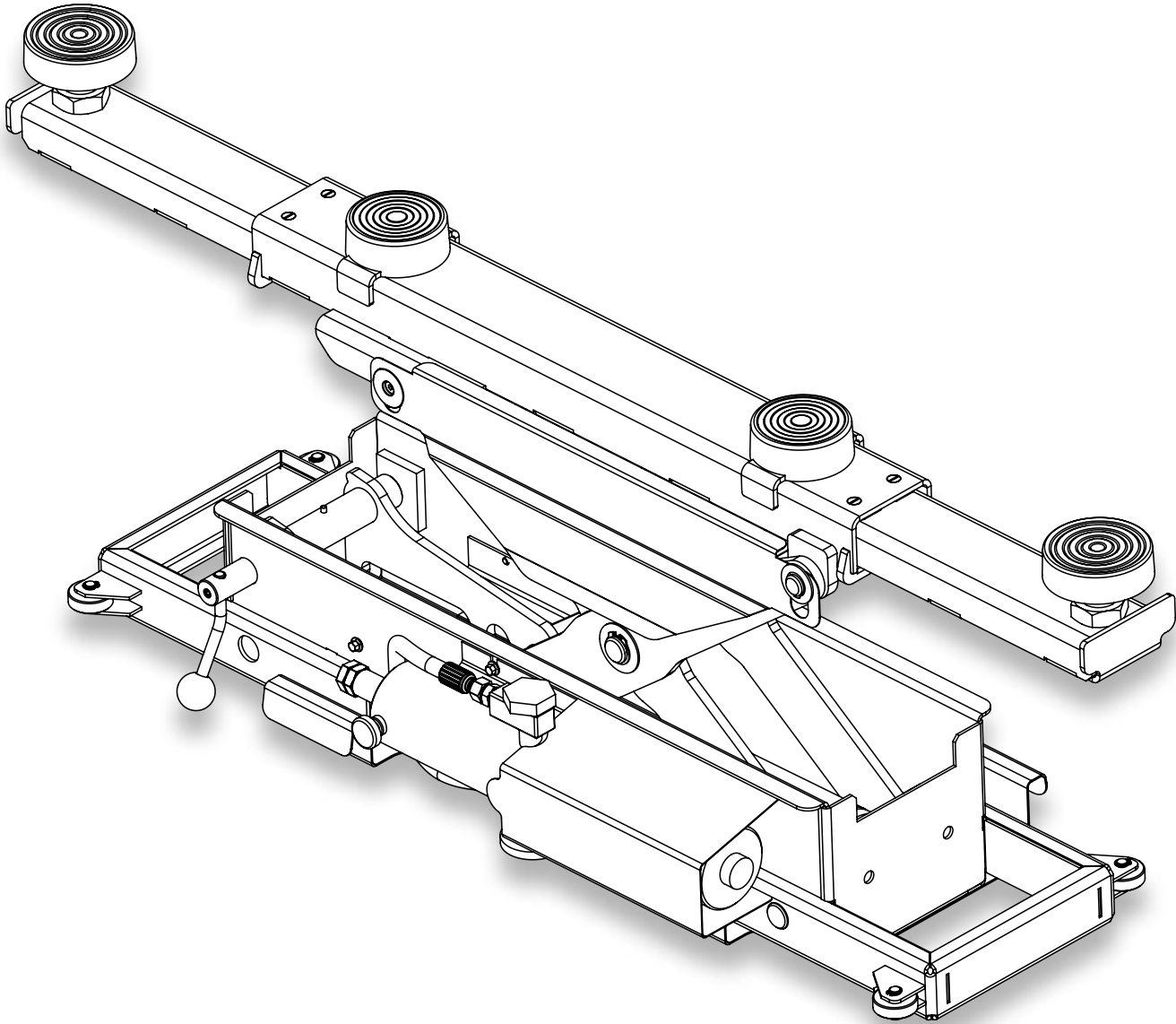

The Air Jacking Beam is for use with Molnar Four Post Hoists. Using a pair of Jacking Beams in tandem provides total 'wheels free' servicing options.

The Air Jacking Beam utilises an air-over-hydraulic pump unit for quick, simple, strong and reliable lifting. The top beam includes sliding extension arms to suit a wide range of vehicles and pick-up points.

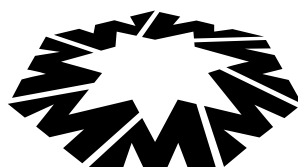



CONTENTS

Overview	02
Features	02
Specifications	03
Safety Precautions	04
Installation	06
Operating	07
Maintenance	08
Hydraulic Oil Replacement	09
Trouble Shooting	10
Accessories	11
Spare Parts Identification	12
Spare Parts List	13
Warranty	14

KEY

	General warning
	Electrical hazard

OVERVIEW

The Air Jacking Beam is an auxiliary lifting mechanism for use with any Molnar Four Post Hoist. Using a pair of Jacking Beams in tandem provides total 'wheels free' servicing options for these hoists.

Designed to address the operational constraints of the modern vehicle servicing workplace, the Air Jacking Beam utilises an air- over-hydraulic pump unit for quick, strong and reliable lifting. The top beam includes sliding extension arms to suit a wide range of vehicles and pick-up points. The unit is simple to operate and includes a range of features to maximise workshop safety and efficiency.

The Air Jacking Beam comes in two widths, for standard and wide Four Post Hoists. 'A' denotes wide series.

FEATURES

- Simple installation on Molnar Four Post Hoists.
- Two tonne lifting capacity per unit (four tonne combined).
- Compact yet powerful air powered hydraulic pump with pressure valve to prevent overloading.
- Rail guide system allows easy unit positioning but restricts movement once load applied.
- Active mechanical load hold mechanism to lock load at both half and full lift height positions.
- Restricted load lowering speed to minimise possibility of injury.
- Shielded lifting mechanism to prevent inadvertent contact or entrapment with moving parts.
- Inbuilt scissor safety guard including integral storage tray side rack for easy storage of pads or other additional lifting aids. The tray also features grasping zones to help when moving the unit.
- Four pick-up pads included with each unit, plus full range of accessories to ensure safe lifting for difficult applications.

As the policy of Molnar Hoists is one of continuous improvement, the manufacturer reserves the right to change specifications without notice. Information is correct and true at time of printing (JULY 2011)



SPECIFICATIONS

	JB11 standard	JB11-A wide
Overall Width	1045 mm	1145 mm
Capacity at nominal 7.0Bar (100psi) air supply pressure	2000 kg	<
Minimum Span (completely closed extension arms)	750 mm	<
Maximum Span (completely open extension arms)	1275 mm	<
Minimum Height (lowered)	75 mm	<
First Lock Position (height above platform top surface)	225 mm	<
Second Lock Position (height above platform top surface)	310 mm	<
Pads Included	2 x J3 pickup pads adjustable (ø100 mm)	<
	2 x J3BP rubber support pads (ø90 mm)	<
Air Supply	filtered and dry air at 7 Bar (100 psi)	<
Air Supply Connection	¼ BSP female port - 10mm min supply line	<
Hydraulic Oil	high quality, 46 weight, anti-wear	<
Gross Weight	91 kg	94 kg
Shipping Dimensions	1100 x 430 x 330 mm	1200 x 430 x 330 mm

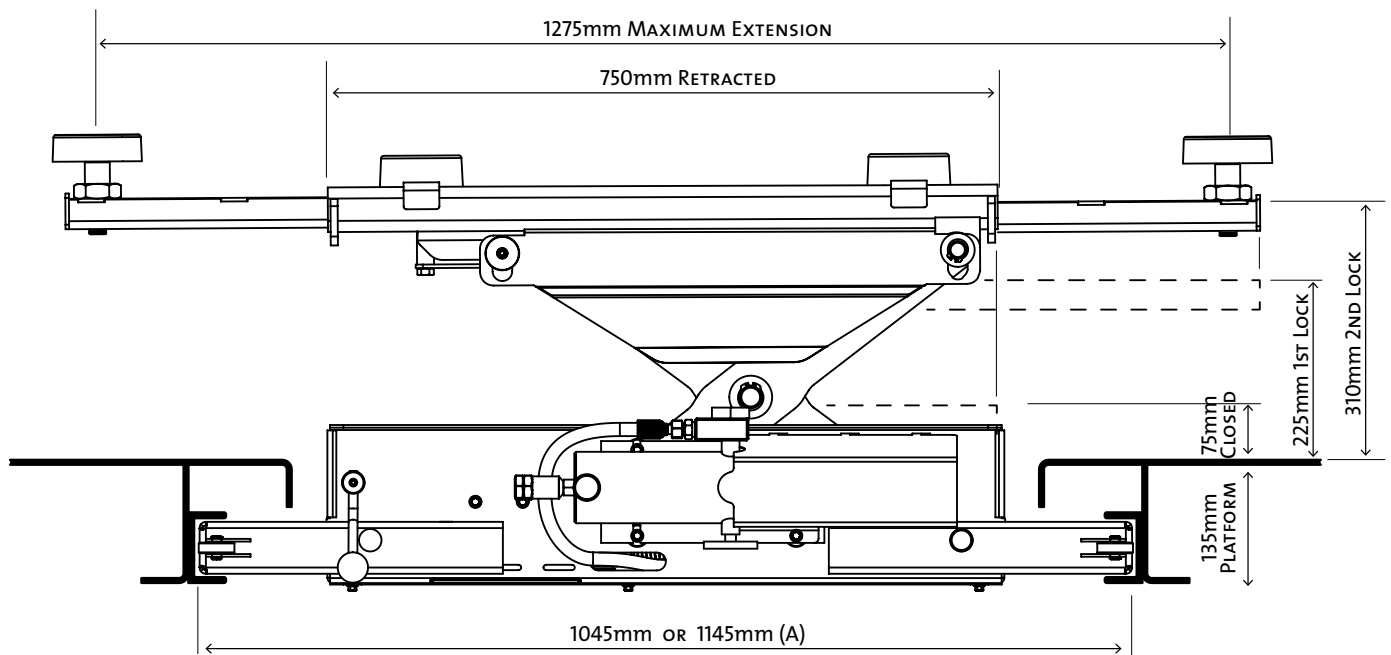



SAFETY PRECAUTIONS

For your own safety and the safety of equipment, always take the following precautions

 Ensure you carefully read and understand the operation and safety instructions detailed in this Manual before using the equipment.



 Load must be locked at all times, except when raising or lowering.



 Use only vehicle manufacturer's pick-up points.

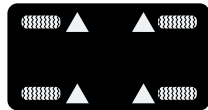

 Keep hands or other obstructions free of the descending unit.

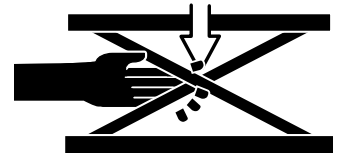

 Monitor vehicle, hoist and area before use and during operation of hoist. Ensure area is clear of any personnel or obstructions when raising or lowering.

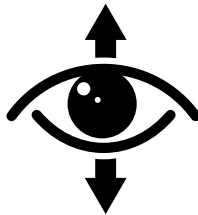

 Unit requires clean (contaminate free) and dry regulated air supply at 7 Bar (100 psi) for correct operation. Unit failure resulting from contaminated air supply will void warranty.



 Do not exceed the rated lifting capacity of the unit (2000 kilograms per unit).



 Regular service and maintenance must be carried out as per the Maintenance requirements detailed in this Manual. Failure to do so may void warranty and cause risk of injury.



 Do not over tighten when closing the Pressure Valve.



 The Hydraulic Pump contains no user serviceable parts and must not be serviced by unauthorised persons. Unit failure resulting from any unauthorised service will void warranty.



 Never operate hoist while load is supported by the Air Jacking Beam. Ensure the Air Jacking Beam is fully closed before raising or lowering the hoist.

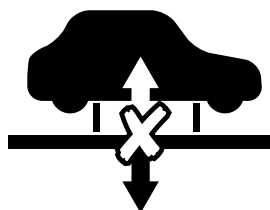



Failure to comply with these precautions may result in loss of load, damage to unit and/or personal injury

⚠ Never use more than one Air Jacking Beam to support load at each end of the hoist. Two units are required for safe lifting of a vehicle.

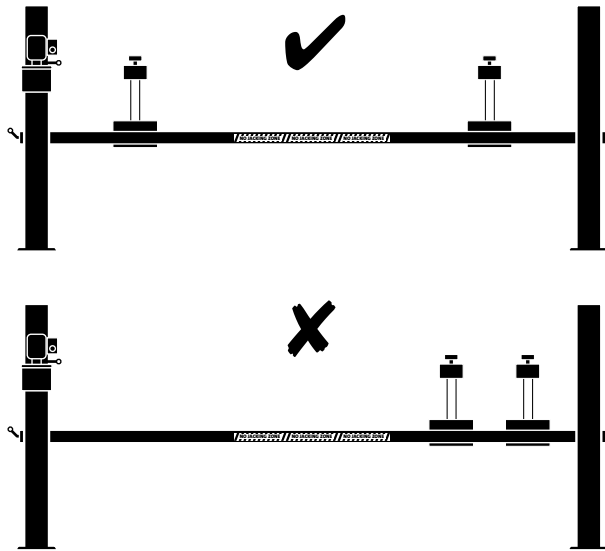

⚠ Supported load must be balanced equally above the centre of the Air Jacking Beam. Ensure that both sides of the Air Jacking Beam are equally loaded.

CORRECT

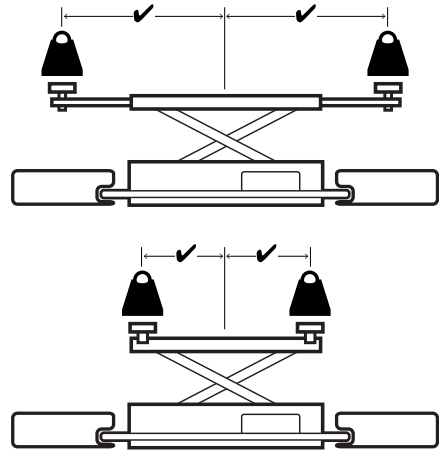

INCORRECT

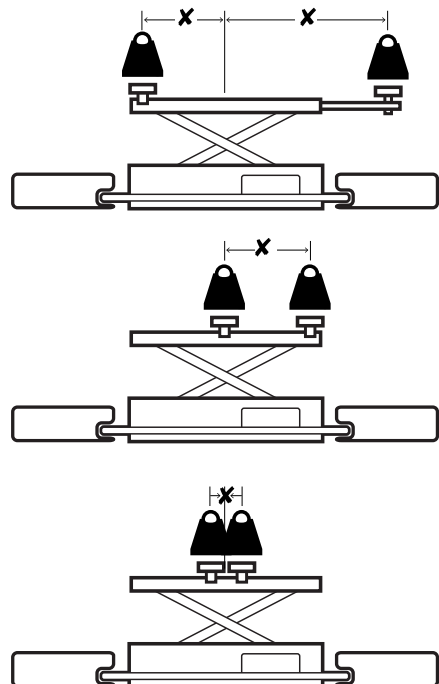

⚠ Air Jacking Beam should not be used within the NO JACKING ZONE. Supporting load within this zone may cause permanent damage to the hoist and risk the safety of the operator.

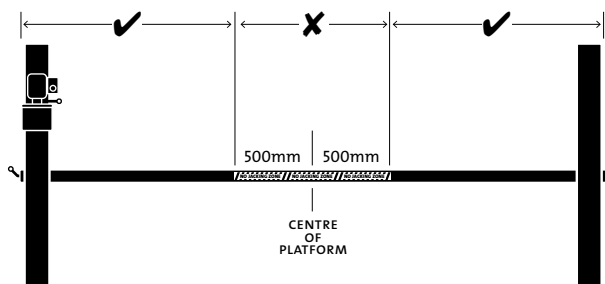



INSTALLATION

YOU WILL NEED

- 6 mm hex key (Allen key)
- long metal pole or other sturdy lever

 **Use two or more people when lifting** (each Air Jacking Beam weighs approximately 90 kg)

 **Do not unpack the Air Jacking Beam prior to installation as the pallet provides a useful platform for ease of installation.**

 **The unit is fully assembled so no additional construction is required.**

- 1 Raise hoist approximately halfway and place Air Jacking Beam carton lengthways between the platforms (anywhere other than within the No Jacking Zone area).



- 2 Lower hoist approximately half a metre from the ground.
- 3 Unscrew the platform furthest from the motor by removing the 2 screws at the furthest corner.

Remove the run-up by lifting and remove 1 screw and loosen the other (as detailed below).

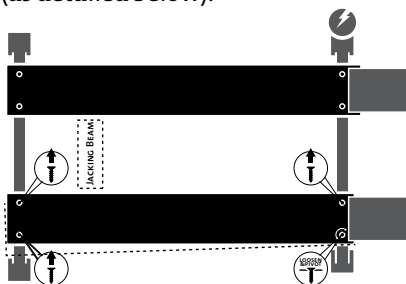

- 4 Lever the platform out towards the posts using a metal pole (or other sturdy lever) until there is enough space to fit the Air Jacking Beam between the platforms.



- 6 Leaving the bottom wooden pallet intact, remove the top carton from the Air Jacking Beam.
- 7 Establish which side you prefer the operating controls (facing inside or outside of the hoist), and rotate the Jacking Beam 90° until it sits across the platforms in the correct position.



- 8 Lower the hoist until the Jacking Beam sits flush with the platform channels.
- 9 Standing over one end of the unit, lift and slide the Jacking Beam support arms into the platform channel. Repeat this process for the other side.

- 10 Use the lever to slide the platform back across until Air Jacking Beam is snug between the platforms. Check the unit is correctly aligned and manually reposition into the channels as needed.



- 11 When fit is correct, push platform fully across to its original position.



- 12 Raise hoist approximately 100 mm and remove the wooden pallet.
- 13 Rescrew all four screws (two screws at each end of the platform) and tighten. (Do not overtighten).



We recommend adding an Anti-Seize lubricant on these countersunk screws

- 14 Replace the run-up by lifting and inserting into slots.
- 15 While the Air Jacking Beam remains close to the ground, manually slide the unit back and forth to ensure free movement along the platforms.



OPERATION

TO RAISE

- 1 Raise vehicle to working height and engage hoist load locks.
- 2 Slide each Air Jacking Beam into position to correctly align with the vehicle manufacturer's pick up points.
- 3 Select the appropriate lifting pads and/or blocks and correctly position them on the upper frame of the Air Jacking Beam, or adjust the inbuilt extension arms to ensure the lifting pads contact the appropriate lifting points on the vehicle.
- 4 Connect the air supply (usually via a quick connect fitting) to the Air Jacking Beam.
- 5 Close the Pressure Valve by turning clockwise. Do not overtighten.
- 6 Hold down the Control Button to raise the Air Jacking Beam until the lifting pads almost touch vehicle pick-up points. Release the Control Button to stop.
- 7 Check the correct alignment of the lifting pads and re-position if necessary. Hold down the Control Button to continue raising the Air Jacking Beam until the lifting pads make contact.

TO HOLD

- 1 Ensure Hold Lock lever is in ON position.
Note: while raising, the Hold Lock lever will move in an anti-clockwise direction before returning to the vertical ON position as it passes the two lock positions (low or high).
- 2 Release Control Button and open the Pressure Valve by turning anti clockwise. The Jacking Beam will lower until load is held by the lock.
- 3 Close the Pressure Valve by turning clockwise (do not overtighten). Check the lock is fully engaged (the Hold Lock lever should remain stationary).

TO LOWER

- 1 Ensure that vehicle wheels are securely fastened, the Air Jacking Beam is clear of obstructions and the Pressure Valve is closed.
- 2 Hold down the Control Button to raise the Air Jacking Beam approximately 50 mm.
- 3 Manually hold the Hold Lock lever in the OFF position (requires approximately 25 mm of vertical lift to disengage the lock).
- 4 TO lower, open the Pressure Valve by turning anti clockwise (do not overtighten). Do not release the Hold Lock lever until the Air Jacking Beam is fully lowered.
- 5 Close the Pressure Valve by turning clockwise to stop lowering. Do not overtighten.
- 6 Remove all lifting pads and blocks. Slide the extension arms back into unit before moving the Air Jacking Beam or the vehicle.
- 7 Remove the air supply line to the Air Jacking Beam before lowering the hoist.

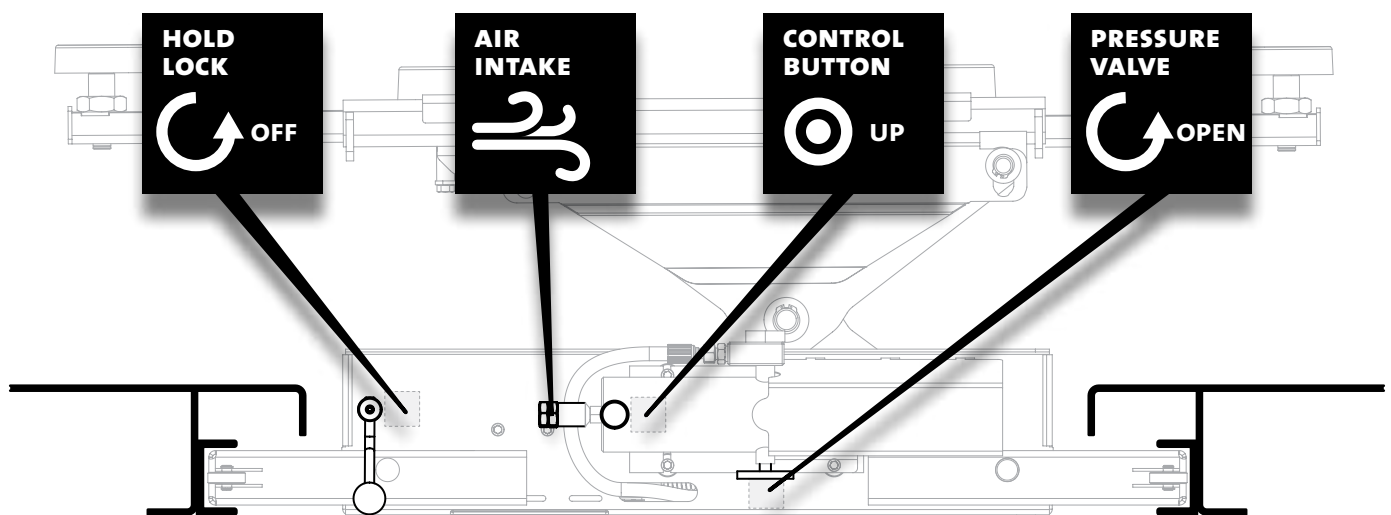



MAINTENANCE

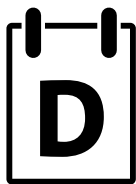

DAILY

- Check for hydraulic oil leaks.
- Check operation of unit through full movement range and load lock positions.
- Check for any loose or missing fasteners.

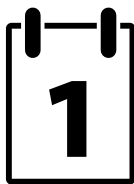

MONTHLY

- Introduce approximately 5 ml of air tool lubricating oil into the pump air intake port to ensure free movement of internal mechanism.
- Lubricate the moving parts on each shaft as identified on the lubrication chart below with a good quality machine oil.



YEARLY

- Drain the hydraulic pump reservoir and replenish with new hydraulic oil. This operation to be performed by a competent person, ideally as part of overall hoist annual maintenance activity.

Refer to “Hydraulic Oil Replacement” on the following page for full details.

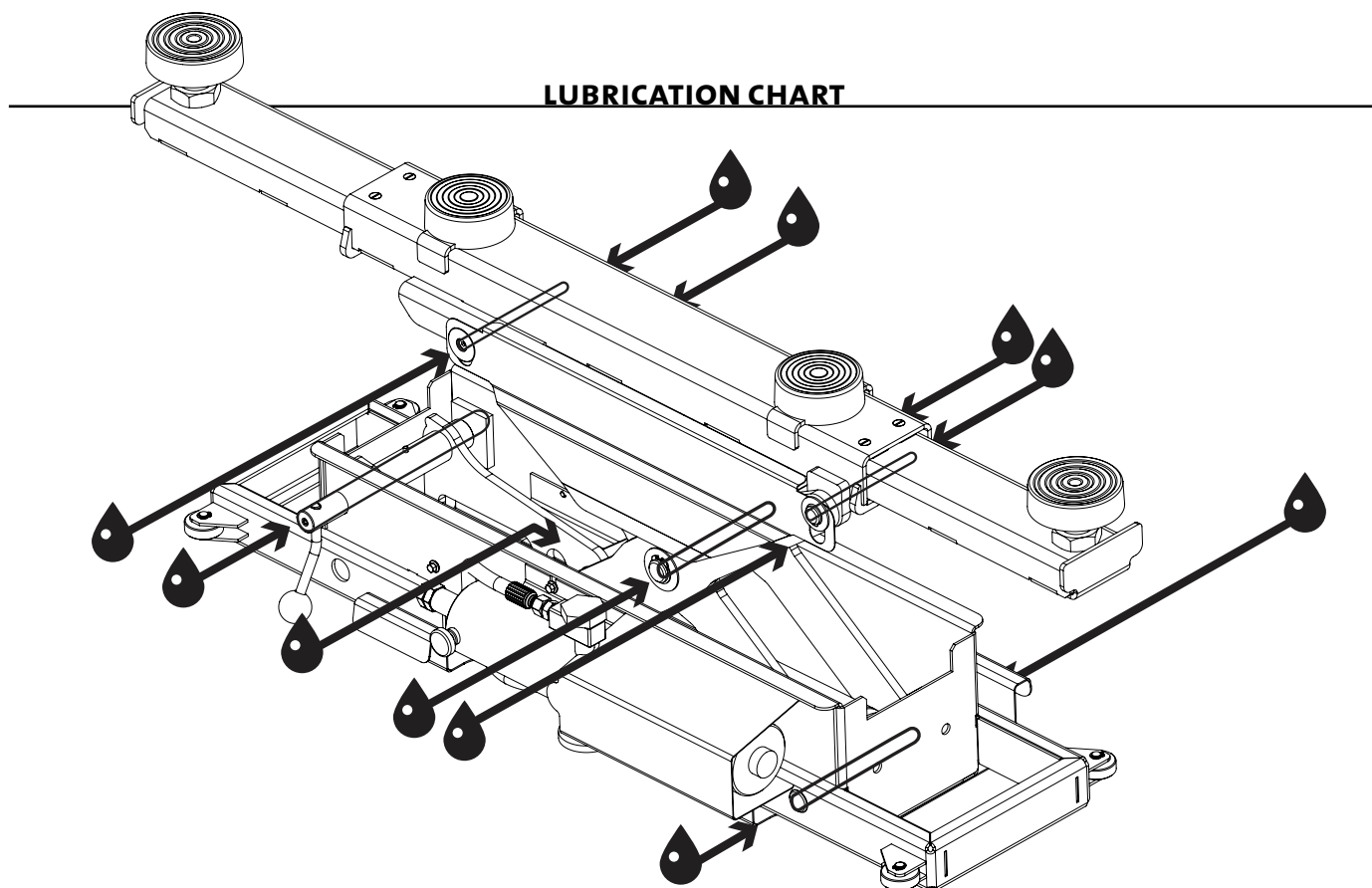



HYDRAULIC OIL REPLACEMENT

YOU WILL NEED

- 10 mm socket wrench
- multi grip pliers
- drain container
- graduated measuring jug
- 💧 600 ml recommended oil (Castrol Hyspin AWH 46 or equivalent)

- 1 Lower hoist to a comfortable working height.
- 2 Ensure the Air Jacking Beam is fully lowered, the Pressure Valve is closed and the air supply is disconnected.
- 3 To remove the pump cover, unscrew the lower right hand bolt using the socket wrench.

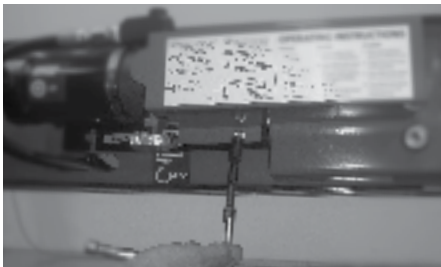

Once removed, lift the cover upwards and outwards to disconnect the three tabs along the top edge. Some gentle force may be required.



- 4 Using the 10 mm socket wrench, loosen the two top pump mounting bolts (do not remove).



- 5 Gently holding the pump unit, loosen the bottom left mounting bolt until the pump is free of the main body. Slowly rotate the pump towards you until pump lifts off. Do not disconnect the pump delivery hose.



- 6 Hold the pump in an upright position and use a multi grip to unscrew and carefully remove the cap.



- 7 Tip the pump to drain the hydraulic oil reservoir into a suitable container until fully drained.
- 8 To refill, tilt the pump at a 45 degree angle and refill with 600 ml of the recommended hydraulic oil (tilting ensures the release of any air trapped in the reservoir).



- 9 Ensure the O-ring is in place in the pump cap before replacing the cap and tightening (do not over tighten).

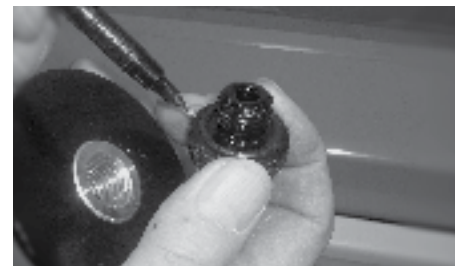

- 10 Tilt pump towards you and slide tabs over lower bolts before pushing to insert upper tabs into bolts. Continue to hold the pump while re-securing all three bolts.



- 11 Check the cap for any oil leaks.
- 12 Replace the pump cover by inserting all three top tabs and replacing the bottom right hand bolt.
- 13 Reconnect the air supply and complete at least one full lift and lower sequence to fully expel any trapped air and ensure correct operation before returning to service.



TROUBLE SHOOTING

Q Pump will not run when Control Button is held down.

A Check the air delivery line is properly connected and not obstructed or kinked, and the air supply is turned on. Ensure you are using clean and dry air at the correct pressure rating of 7 Bar.

Q Pump runs but Air Jacking Beam does not lift.

A Check that the Pressure Valve is fully closed.

Q Pump runs but Air Jacking Beam will not lift to full height.

A Check for low oil level in the hydraulic pump reservoir and replenish as needed (refer to Hydraulic Oil Replacement instructions).

Q Pump stops when load is applied.

A Supply air pressure is low, or load exceeds the Air Jacking Beam lift capacity.

Q Pump runs but makes a “rattling” noise.

A Check for low oil level or trapped air in the hydraulic pump reservoir. Replenish oil as per Hydraulic Oil Replacement instructions. Introduce air tool lubricating oil as per the monthly maintenance schedule.

Q Unit makes a “grating” noise when lifting a load.









A Lubricate the moving parts as per the monthly maintenance schedule.

Q Pump runs but makes a loud “hammering” noise, and the raise speed is slow

A Air supply line may be too small. Minimum air supply hose diameter 10 mm (internal) is recommended.



ACCESSORIES

<p>PL92-RB RUBBER BLOCK, STANDARD</p>		<p>Solid rubber block for cushioned lifting For use on Rubber Block Nest</p>	<p>Length 150 mm Width 100 mm Height 70 mm</p>
<p>PL92-RB-40 RUBBER BLOCK, LOW PROFILE</p>		<p>For vehicles with low clearance For use on Rubber Block Nest</p>	<p>Length 150 mm Width 100 mm Height 40 mm</p>
<p>SLO2-NEST RUBBER BLOCK NEST</p>		<p>Nest to house rubber blocks</p>	<p>Length 160 mm Width 100 mm Height 120 mm</p>
<p>J3BP BEAM PAD</p>		<p>Stabilises vehicles on beams Made from solid, long-lasting vulcanised rubber</p>	<p>Diameter 90 mm Pad Height 30 mm</p>
<p>J3 PICK UP PAD, SMALL</p>		<p>Supports and stabilises vehicle</p>	<p>Diameter 100 mm Height - min 30 mm Height - max 80 mm</p>
<p>EXT-PAD BEAM RISER, STANDARD</p>		<p>Provides valuable extra clearance for four-wheel-drives and vans</p>	<p>Length 120 mm Width 100 mm Height - min 170 mm Height - max 215 mm</p>
<p>EXT-PAD-LOW BEAM RISER, LOWERED</p>		<p>For vehicles with low clearance</p>	<p>Length 120 mm Width 100 mm Height - min 140 mm Height - max 175 mm</p>
<p>AXLE-PU BEAM RISER, AXLE</p>		<p>For stable pick-up on axle; cradle head prevents lateral movement</p>	<p>Length 120 mm Width 100 mm Height - min 150 mm Height - max 205 mm</p>

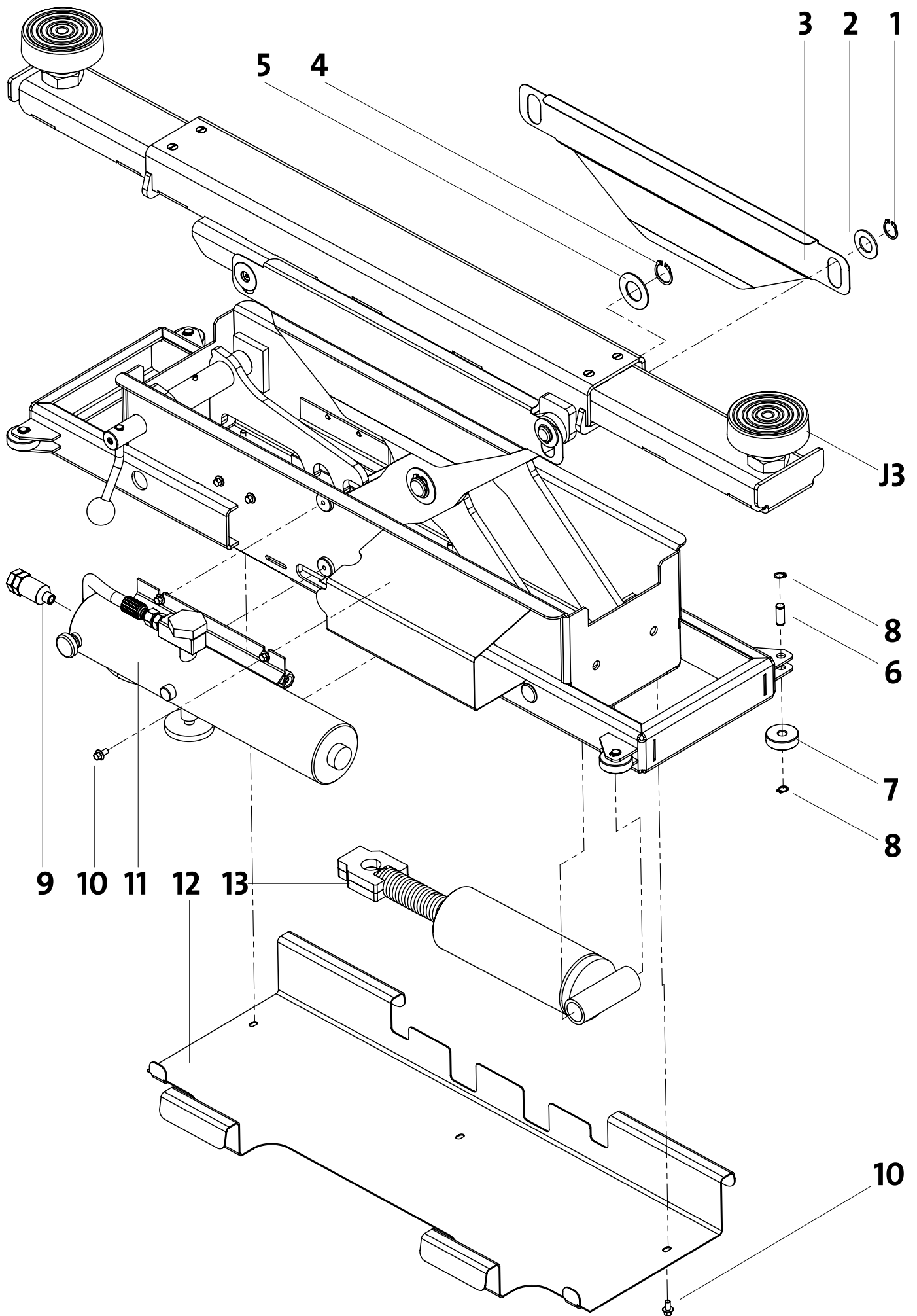



ITEM	PART DESCRIPTION	SPARE PART NUMBER
1	CIRCLIP 20 mm (D1400-020)	1012012
2	WASHER FLAT 20 mm	1017006
3	COVER PLATE, SIDE	32A31011
4	CIRCLIP 25 mm (D1400-0250)	1012013
5	WASHER FLAT 25 mm	1017005
6	PIN, GUIDE ROLLER	JB87-42
7	GUIDE ROLLER	JB87-43
8	CIRCLIP 10 mm (DIN 471-10)	85A-J-46
9	INLINE AIR FILTER COMPLETE	SL02-147
10	BOLT M6 x 12 mm	85A-D-11
11	PUMP ASSEMBLY	32A24002
12	COVER PLATE, BOTTOM	32A31012
13	CYLINDER ASSEMBLY	32A24001
J3	PICK UP PAD, SMALL	J3

To ORDER

To order spare parts or accessories, simply

call **08 7120 8700**

email info@molnarhoists.com.au

or log onto www.molnarhoists.com.au/spare-parts



WARRANTY

All Molnar Hoists products are made in Australia and built to the highest safety standards.

Our commitment to excellence is backed by our warranty on products and genuine parts – matching our manufacturing excellence with superior service assurance.

Molnar Hoists will repair or replace defective product in accordance with our standard Warranty terms and conditions in effect at the time of purchase. Simply contact your local authorised dealer or Molnar Hoists to initiate a warranty claim.

A copy of our complete Warranty Statement is available to download from our website www.molnarhoists.com.au/warranty.





For more information, please contact us or your local Molnar Representative

16-20 Coglin Street Brompton SA 5007 Australia
T 08 7120 8700 **F** 08 8346 0097 **E** info@molnarhoists.com.au
www.molnarhoists.com.au

onwards & upwards